



**ATTENTION**  
OBSERVE PRECAUTIONS  
FOR HANDLING  
ELECTROSTATIC  
DISCHARGE  
SENSITIVE  
DEVICES



## Features

- Long operating life
- Highest flux
- Wide range of colours:2500K-25000K
- More energy efficient than incandescent and most halogen lamps
- Low voltage DC operated
- Cool beam, safe to the touch
- Instant light (less than 100ns )
- Fully dimmable
- No UV
- Superior ESD protection
- RoHS compliant

## Applications

- Fiber optic alternative/Decorative/entertainment
- Mini-accet/Up lighters/Down lighters/ Orientation
- Indoor/Outdoor commercial and Residential Architectural
- Cove/Under shelf/Task
- Bollards/Security/Garden
- Portable(flashlight,bicycle)
- Edge-lit signs(Exit,point of sale)
- Automotive Exit (Stop-Tail-Tum,CHMSL,Mirror Side Repeat)
- Traffic signaling/Beacons/RailCrossing and Wayside

## Radiation Pattern

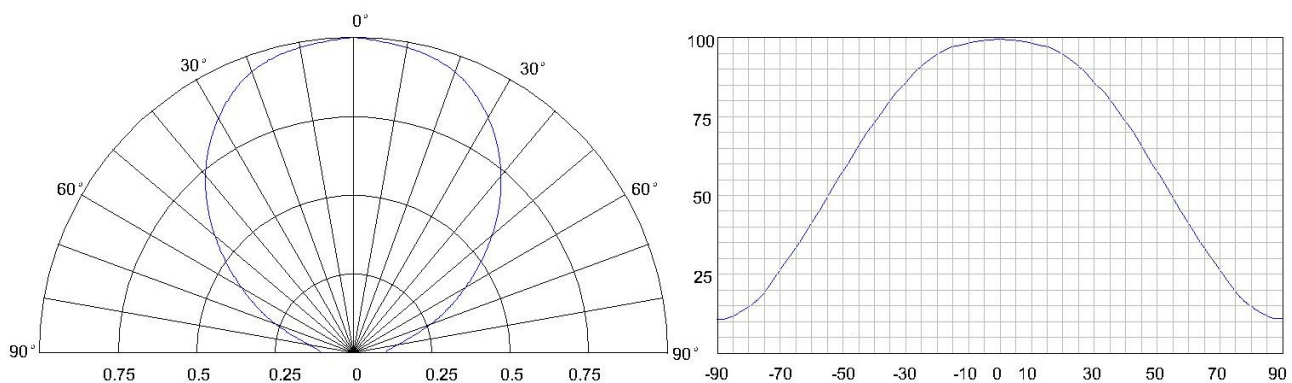

### Typical Optical/ Electrical Characteristics @T<sub>a</sub>=25°C

Item	Symbol	Condition	Min.	Typ.	Max.	Unit
Forward Voltage	V <sub>F</sub>	I <sub>F</sub> =1.6A	6	8	—	V
Reverse Current	I <sub>R</sub>	V <sub>R</sub> =5v	--	--	50	uA
50% Power Angle	2θ <sub>1/2</sub>	I <sub>F</sub> =1.6A	110	--	140	deg
Luminous Flux	φ <sub>v</sub>	I <sub>F</sub> =1.6A	490			lm
Recommend Forward Current	I <sub>F</sub>	--	--	1.6	--	A
Chromaticity	T <sub>c</sub>	I <sub>F</sub> =1.6A	2870		3220	k

The sample delivers goods data

Item	Symbol	Condition	Min.	Avg.	Max.	Unit
Luminous Flux	φ <sub>v</sub>	I <sub>F</sub> =1.6A				lm
50% Power Angle	2θ <sub>1/2</sub>					deg
Forward Voltage	V <sub>F</sub>					v
Chromaticity	T <sub>c</sub>					k
White Color Region			--			
ChromaticityCoordinates			X=--		Y=--	

#### Notes:

- 1.Tolerance of measurement of forward voltage±0.1V.
- 2.Tolerance of measurement of peak Wavelength±2.0nm.
- 3.Tolerance of measurement of luminous flux±15%.

### Absolute Maximum Rating

Item	Symbol	Absolute Maximum Rating	Unit
Forward Current	I <sub>F</sub>	1.6	A
Peak Forward Current*	I <sub>FP</sub>	1.7	A
Reverse Voltage	V <sub>R</sub>	5	V
Power Dissipation	P <sub>D</sub>	10	W
Electrostatic discharge	E <sub>SD</sub>	±2000	V
Operation Temperature	T <sub>OPR</sub>	-40~+80	°C
Storage Temperature	T <sub>STG</sub>	-40~+100	°C
Lead Soldering Temperature*	T <sub>SOL</sub>	Max. 260°C for 3sec Max.	

\*IFP Conditions: Pulse Width≤10msec duty≤1/10

\* All high power emitter LED products mounted on aluminum metal-core printed circuit board, can be lighted directly, but we do not recommend lighting the high power products for more than 5 seconds without a appropriate heat dissipation equipment.

\*Please don't add or change wires,while LEDS is running

\* The LED of this a series can lead the heat reflux of 250 Celsius degrees Han but be free from damage.

## Typical Optical/Electrical Characteristics Curves ( $T_a=25^\circ\text{C}$ Unless Otherwise Noted )

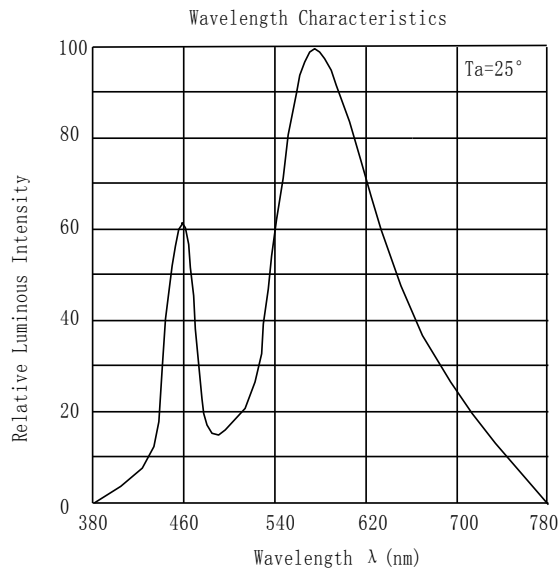
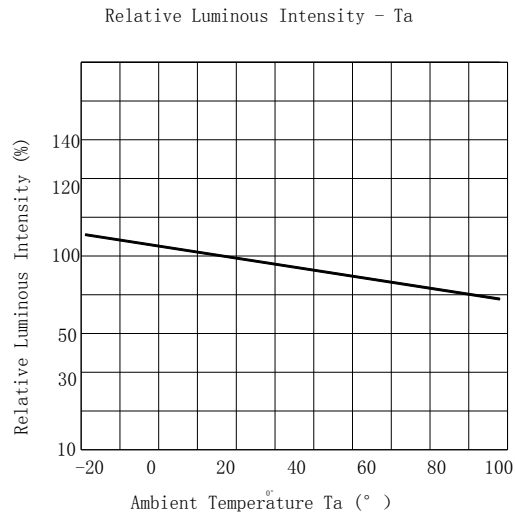
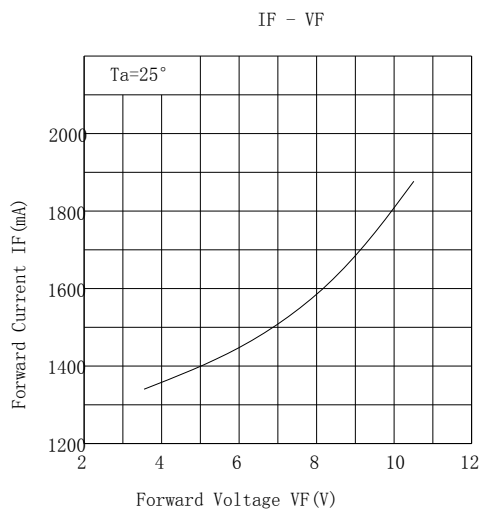
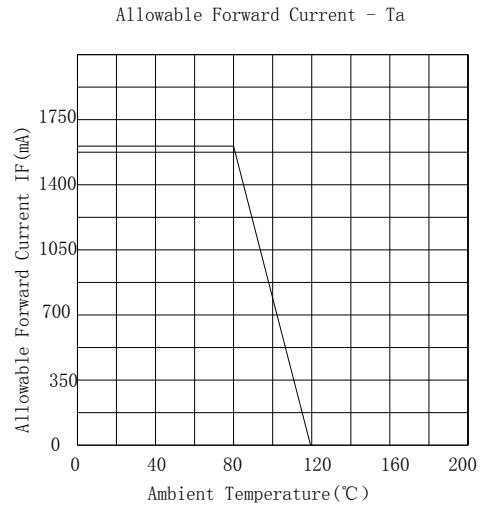
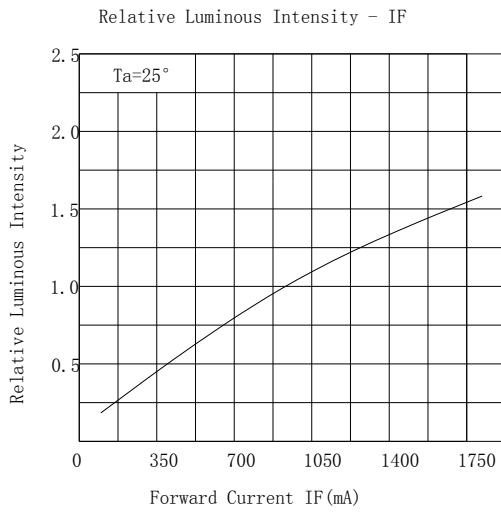

## Package Dimensions

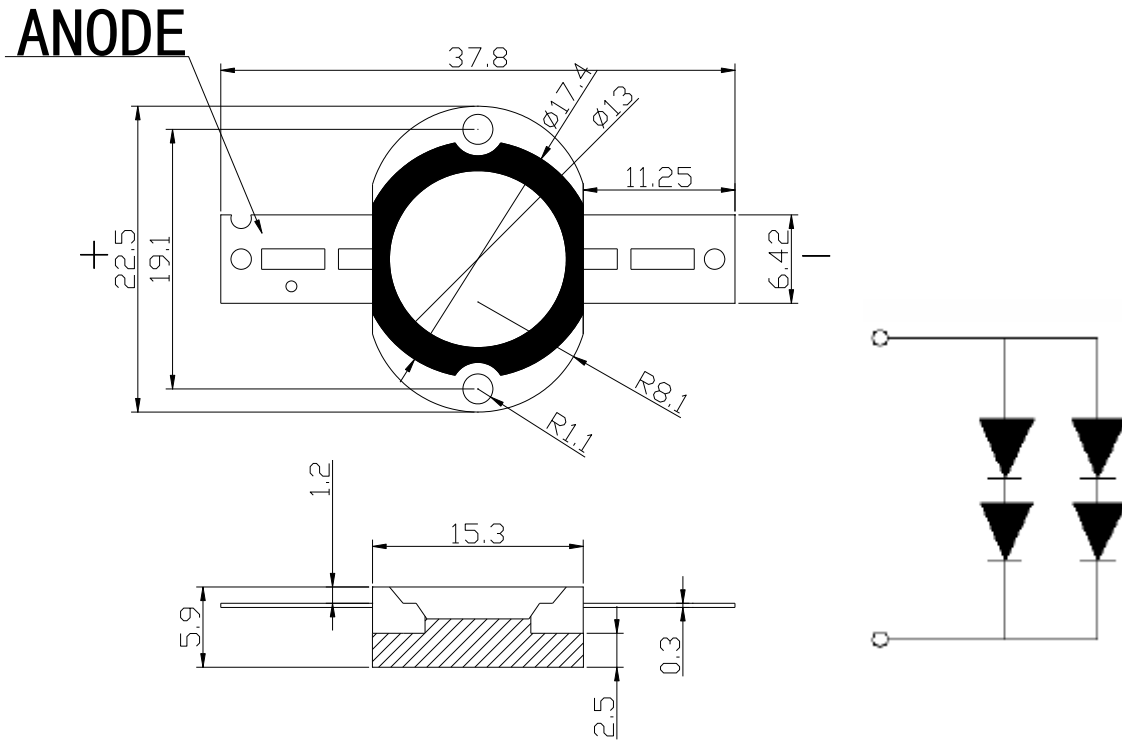

### Notes:

1. All dimension units are millimeters.
2. All dimension tolerance is  $\pm 0.2\text{mm}$  unless otherwise noted.