

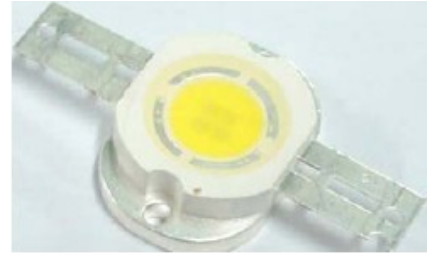

ATTENTION
OBSERVE PRECAUTIONS
FOR HANDLING
ELECTROSTATIC
DISCHARGE
SENSITIVE
DEVICES



Features

- Long operating life
- Highest flux
- Available in Blue
- More energy efficient than incandescent and most halogen lamps
- Low voltage DC operated
- Cool beam, safe to the touch
- Instant light (less than 100ns)
- Fully dimmable
- No UV
- Superior ESD protection
- RoHS compliant

Applications

- Fiber optic alternative/Decorative/entertainment
- Mini-acct/Up lighters/Down lighters/ Orientation
- Indoor/Outdoor commercial and Residential Architectural
- Cove/Under shelf/Task
- Bollards/Security/Garden
- Portable(flashlight,bicycle)
- Edge-lit signs(Exit,point of sale)
- Automotive Exit (Stop-Tail-Tum,CHMSL,Mirror Side Repeat)
- Traffic signaling/Beacons/RailCrossing and Wayside

Radiation Pattern

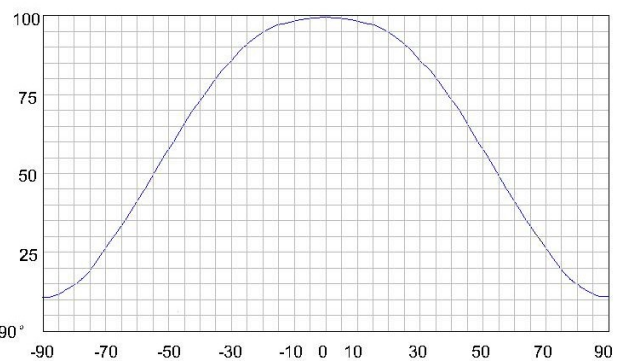
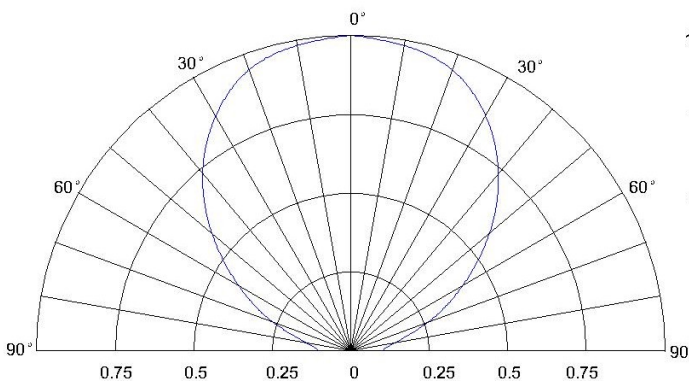

Typical Optical/ Electrical Characteristics @T_a=25°C

Item	Symbol	Condition	Min.	Typ.	Max.	Unit
Forward Voltage	V _F	IF=1.6A		16		V
Reverse Current	I _R	VR=10v	--	--	50	uA
50% Power Angle	2θ1/2	IF=1.6A	110	--	140	deg
Luminous Flux	φ _v	IF=1.6A	1080			lm
Recommend Forward Current	I _F	--	--	1.6		A
Chromaticity	T _c	IF=1.6A	6020		7040	K

The sample delivers goods data

Item	Symbol	Condition	Min.	Typ.	Max.	Unit
Luminous Flux	φ _v	IF=1.6A				lm
50% Power Angle	2θ1/2					deg
Forward Voltage	V _F					v
Chromaticity	T _c					K

Notes:

1. Tolerance of measurement of forward voltage ±0.1V.
2. Tolerance of measurement of peak Wavelength ±2.0nm.
3. Tolerance of measurement of luminous flux ±15%.

Absolute Maximum Rating

Item	Symbol	Absolute Maximum Rating	Unit
Forward Current	I _F	1.6	A
Peak Forward Current*	I _{FP}	1.7	A
Reverse Voltage	V _R	5	V
Power Dissipation	P _D	20	W
Electrostatic discharge	E _{SD}	±4500	V
Operation Temperature	T _{OPR}	-30~+80	°C
Storage Temperature	T _{STG}	-40~+100	°C
Lead Soldering Temperature*	T _{SOL}	Max. 260°C for 3sec Max.	

*IFP Conditions: Pulse Width ≤ 10msec duty ≤ 1/10

* All high power emitter LED products mounted on aluminum metal-core printed circuit board, can be lighted directly, but we do not recommend lighting the high power products for more than 5 seconds without a appropriate heat dissipation equipment.

*Please don't add or change wires, while LEDS is running

* The LED of this a series can lead the heat reflux of 250 Celsius degrees Han but be free from damage.

Typical Optical/Electrical Characteristics Curves
($T_a=25^{\circ}\text{C}$ Unless Otherwise Noted)

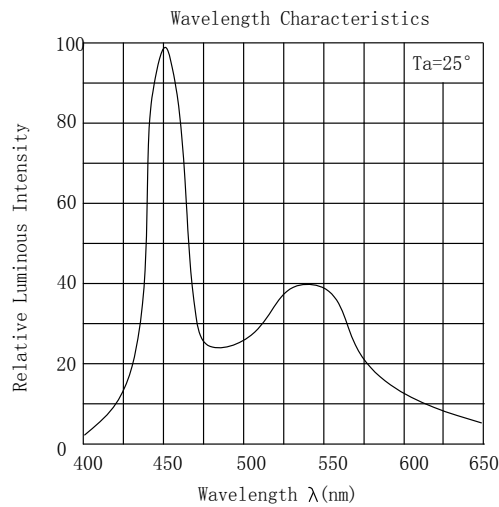
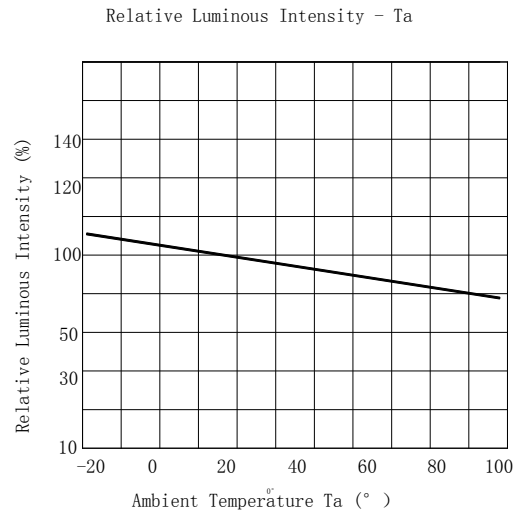
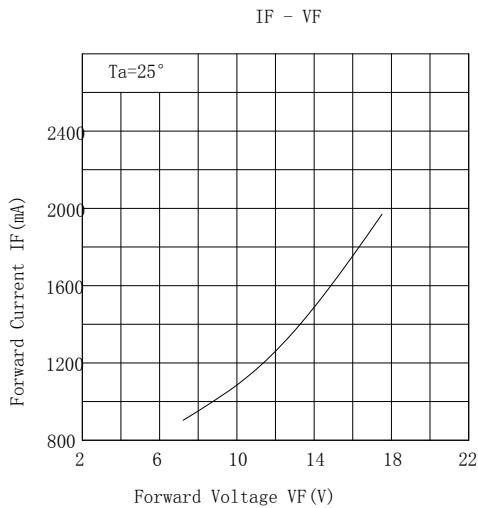
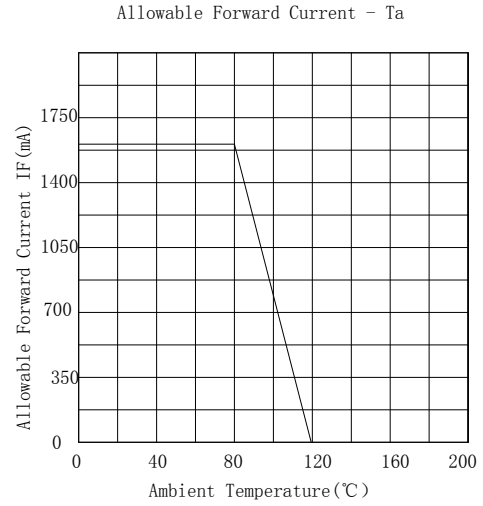
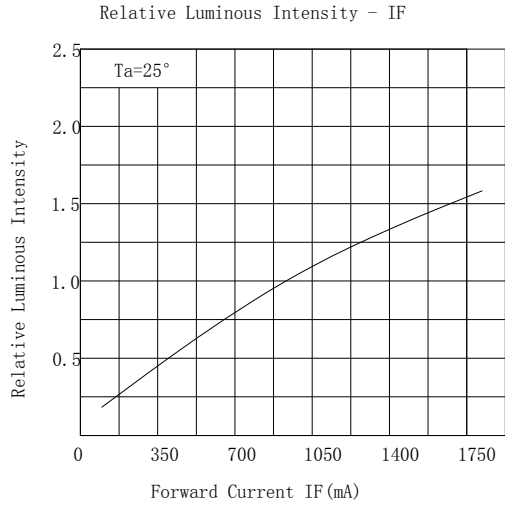

Package Dimensions

ANODE

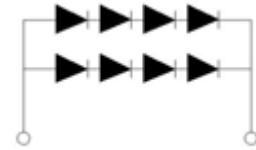
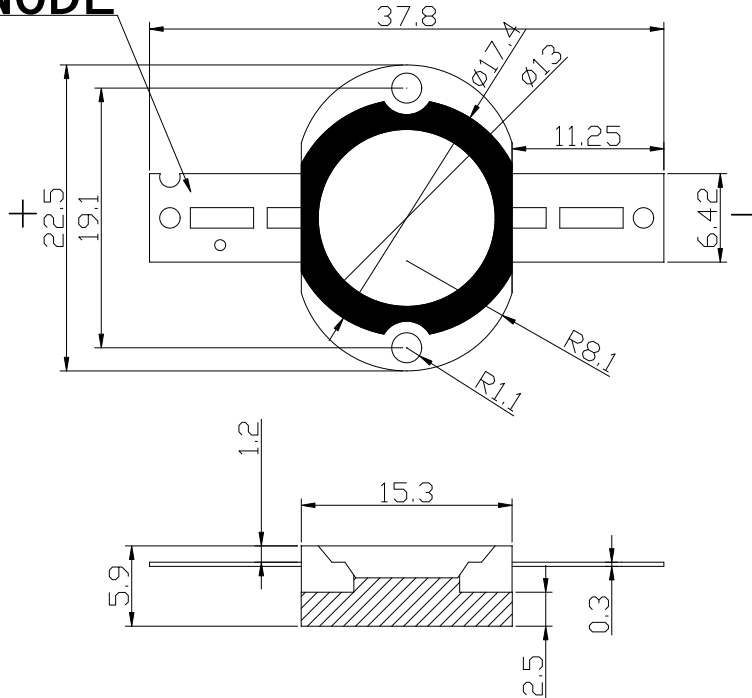

Notes:

1. All dimension units are millimeters.
2. All dimension tolerance is $\pm 0.2\text{mm}$ unless otherwise noted.