

*High Power Solid-State LED Light Source*

# LUSTRON X5

## Introduction

For a brighter solid-state light source, Lustrous Technology is proud to release the new **LUSTRON X5**. Ideal for your high lumen output design, **LUSTRON X5** has the ability to generate extremely high lumen output from 930 to 1,250 lm on one single LED product. The **LUSTRON X5** is energy efficient, and provides high efficiency while performing its high lumen for all types of Commercial and Architectural applications. A 10-watt driver is all you need to start the high lumen engine for your next bright design.

Note: To optimize the performance and lifetime, please maintain a constant current of less than the indicated  $T_b$  at 50°C.

**LUSTRON X5**

---

---

**LUSTROUS**<sup>®</sup>  
*GREEN TECHNOLOGY OF LIGHTING*

**LUSTRON X5 Part Number Matrix**

Table.1

Color	P/N
Warm White	L510CLCNBA
	L510CLIGBA
Neutral White	L510MWCNBA
	L510MWIGBA
Cool White	L510NWCNDA
	L510NWIGDA

**LUSTRON X5 Material**

Chip Material	GaN Base
---------------	----------

**LUSTRON X5 Chips Array**

54 Chips Array
----------------

---

**LUSTRON X5**

## Mechanical Dimensions

### LUSTRON X5

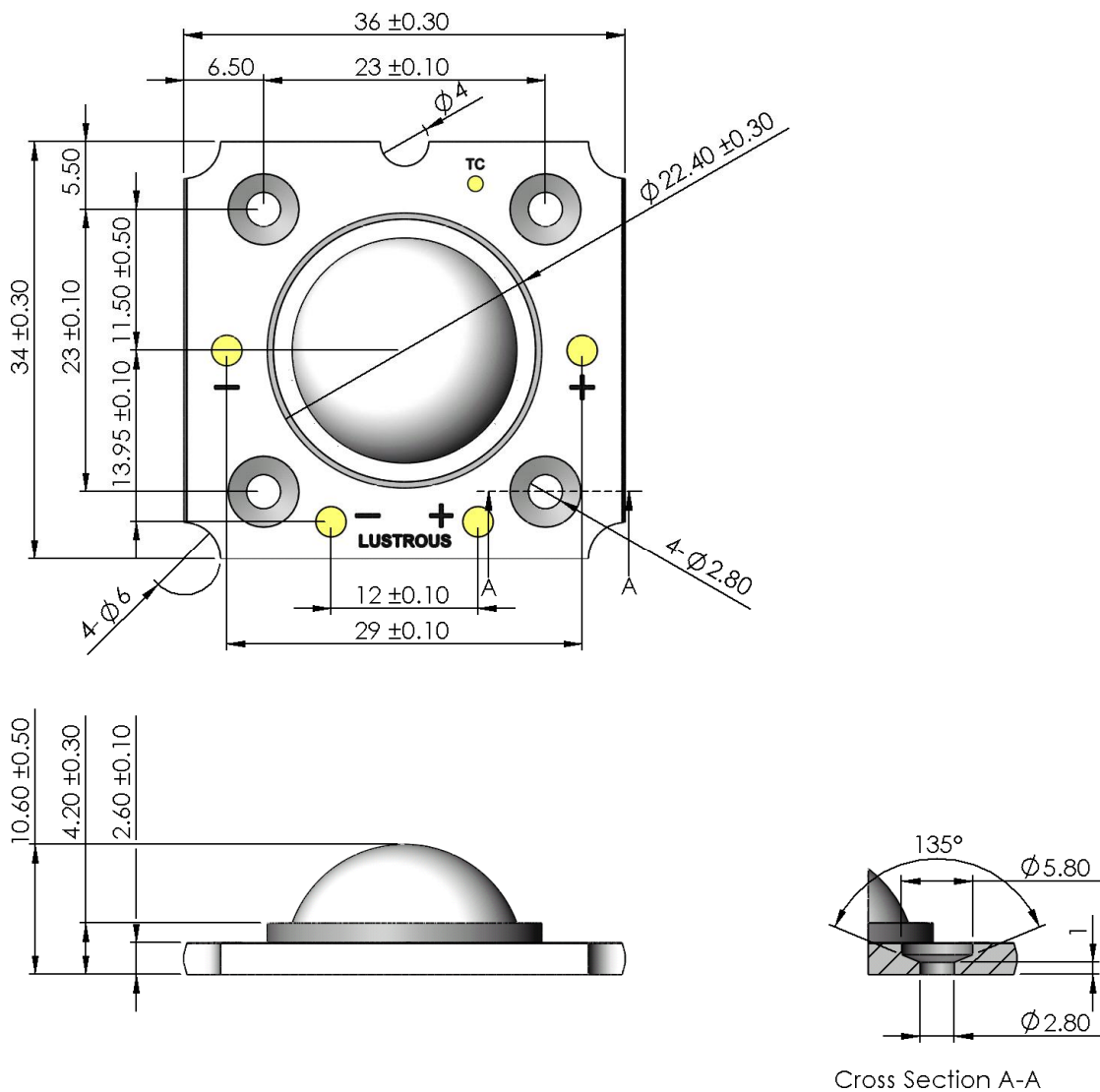

Note: These drawings are not for scale. All dimensions are in millimeters.

### LUSTRON X5

**Recommended installation screw pitch**

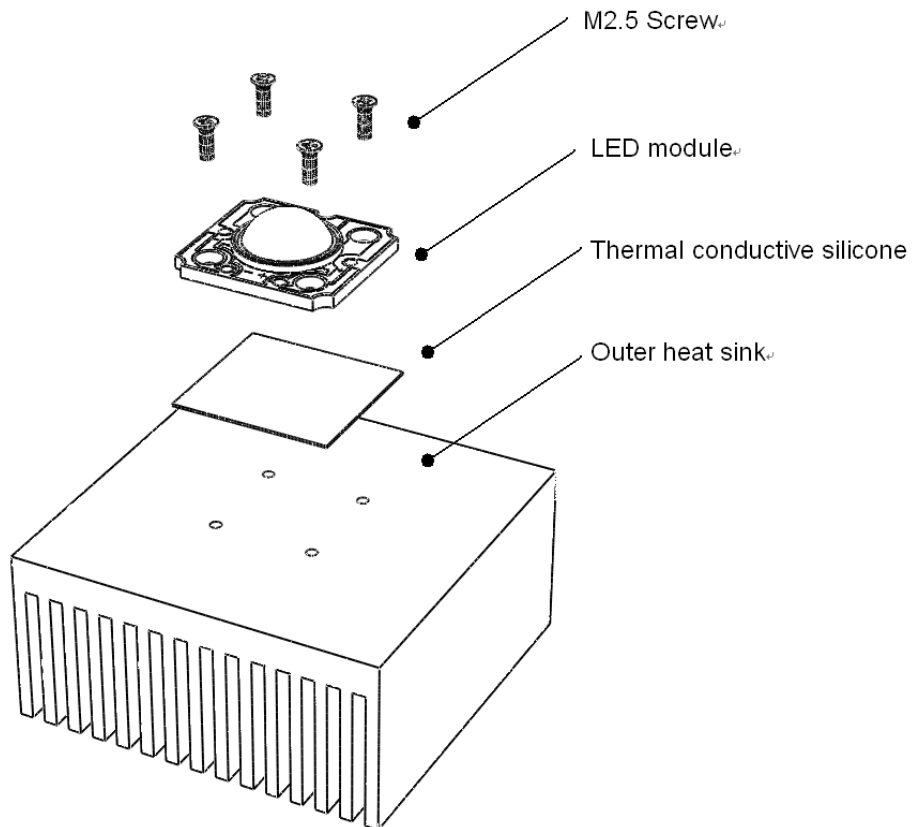

**Warning:**

**Do not** touch the lighting surface area during installation.

# LUSTROUS<sup>®</sup>

GREEN TECHNOLOGY OF LIGHTING

## Flux Characteristics At Junction Temperature T<sub>j</sub> = 25°C

Table.2

Color	Luminous flux (lm)	
	Minimum	Typical
Warm White ( 3000K )	740	930
Neutral White ( 4000K )	860	1050
Cool White ( 5000K )	980	1250

Note1 : Luminous flux is measured in total power with tolerance rate of ±10%. Minimum luminous flux performance is guaranteed from the above data.

Note2 : Luminous binning information can be found in Table.7.

## Optical Characteristics

Table.3

Color	λ <sub>d</sub> ( nm ) or CCT ( K )			Viewing Angle ( degrees )	CRI
	Min	Typ	Max		
Warm White	2500K	3000K	3250K	~130	85
Neutral White	3250K	4000K	4750K		80
Cool White	4750K	5000K	10000K		65

Note1 : CRI value is measured with tolerance rate of ±10%.

# LUSTRON X5

## Electrical Characteristics

Table.4

Part Number	Forward Voltage (V) for 1050mA forward current		
	Min	Typ	Max
	L510XXCNXX	8.7	9.6

Part Number	Forward Voltage (V) for 350mA forward current		
	Min	Typ	Max
	L510XXIGXX	26.1	28.8

Note1: Lustrous Technology allows a tolerance of each LED for voltage measurements.

Note2: Measurements are taken under each nominal forward current.

## Absolute Maximum Ratings

Table.5

Parameters	For 1050mA forward current
	L510XXCNXX
Advised DC Forward Current (mA)	1050
Max. DC Forward Current (mA)	1620
LED Junction Temperature (°C)	<115
ESD Sensitivity	+/- 4kV (HBM)
Thermal Resistance (°C/W)	~1.5
Operating Temperature (°C)	-20 ~ +80
Storage Temperature (°C)	-20 ~ +50

Parameters	For 350mA forward current
	L510XXIGXX
Advised DC Forward Current (mA)	350
Max. DC Forward Current (mA)	540
LED Junction Temperature (°C)	<115
ESD Sensitivity	+/- 4kV (HBM)
Thermal Resistance (°C/W)	~1.5
Operating Temperature (°C)	-20 ~ +80
Storage Temperature (°C)	-20 ~ +50

Note1: Proper current operating must be observed to maintain junction temperature below the maximum.

**LUSTROUS**<sup>®</sup>  
GREEN TECHNOLOGY OF LIGHTING

**Relative Intensity vs. Current (T<sub>j</sub> = 25°C)**

**L510XXCNXX**

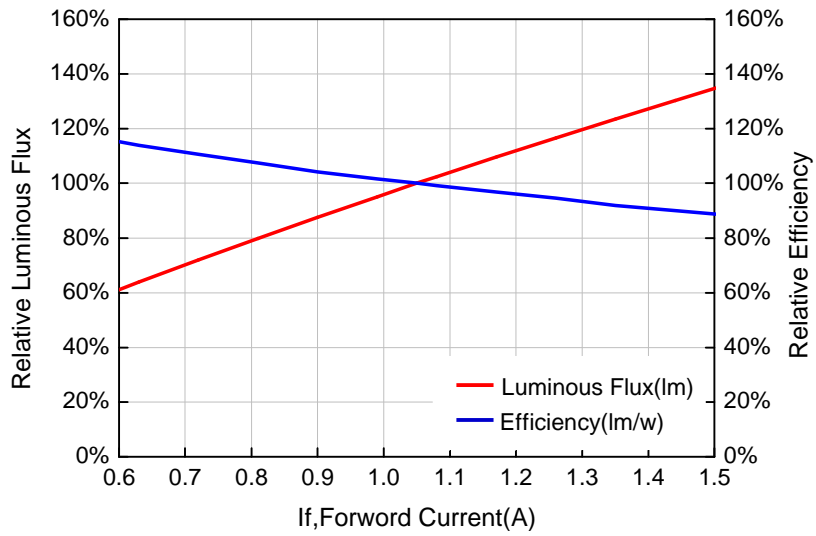

**L510XXIGXX**

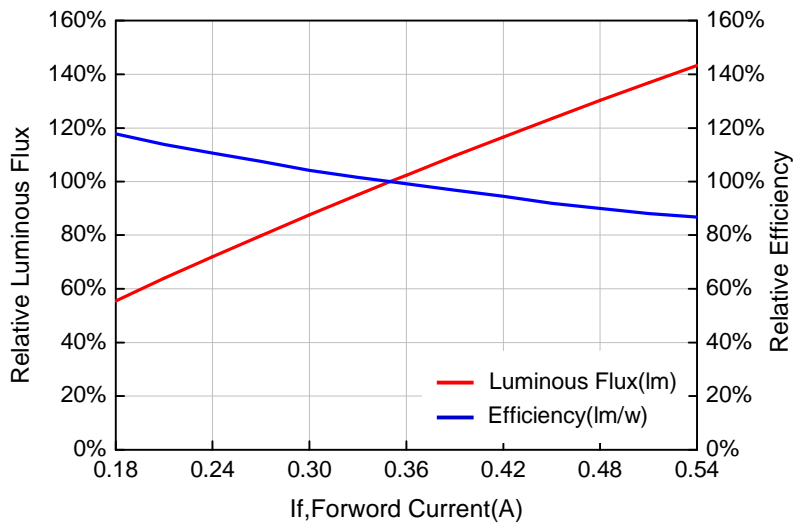

**LUSTRON X5**



**Forward Voltage vs. Current (T<sub>j</sub> = 25°C)**

**L510XXCNXX**

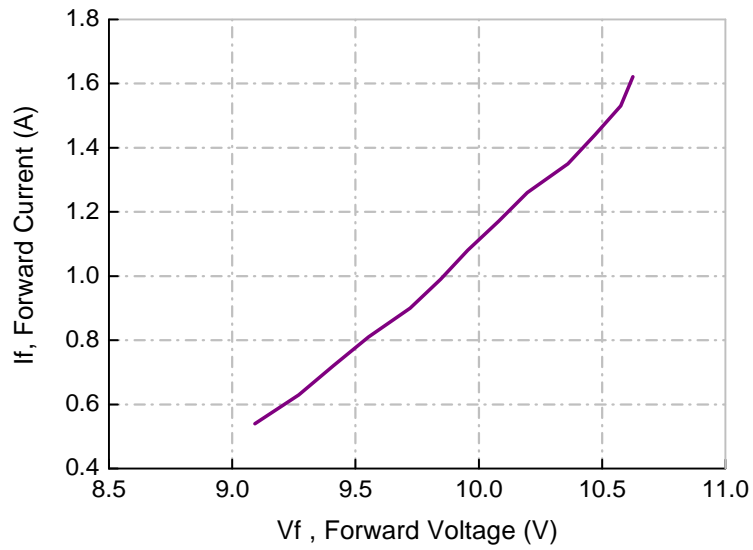

**L510XXIGXX**

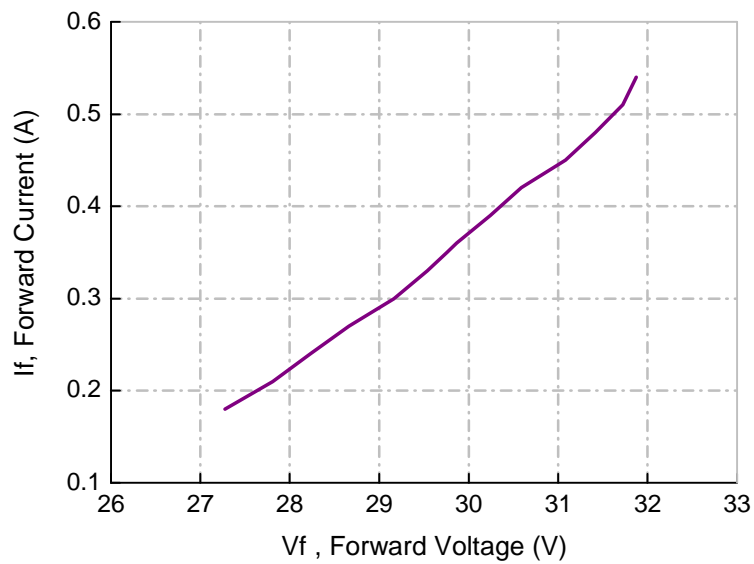

---

# LUSTROUS<sup>®</sup>

GREEN TECHNOLOGY OF LIGHTING

## Photometric Output vs. Board Temperature

L510XXCNXX/ L510XXIGXX

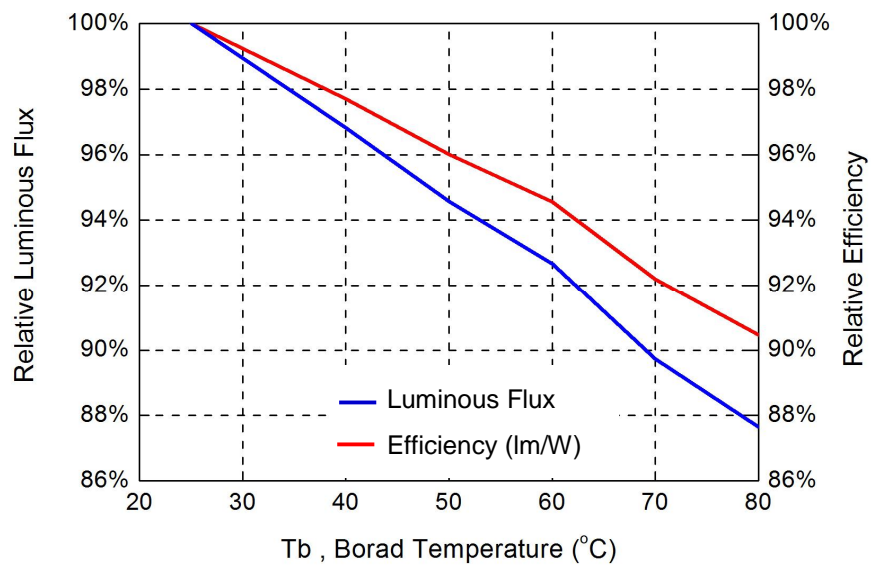

---

## LUSTRON X5

---

# LUSTROUS<sup>®</sup>

GREEN TECHNOLOGY OF LIGHTING

## Relative Spectral Power

### Warm White (3000K)

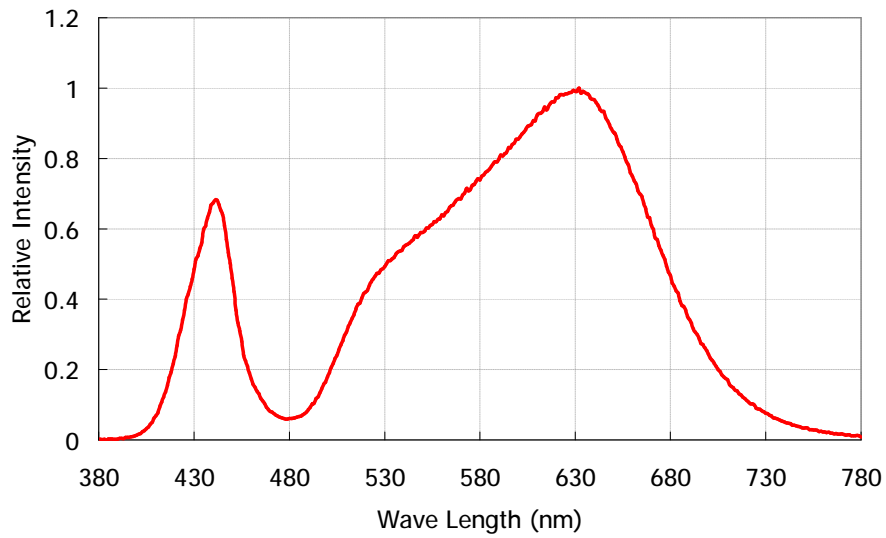

### Neutral White (4000K)

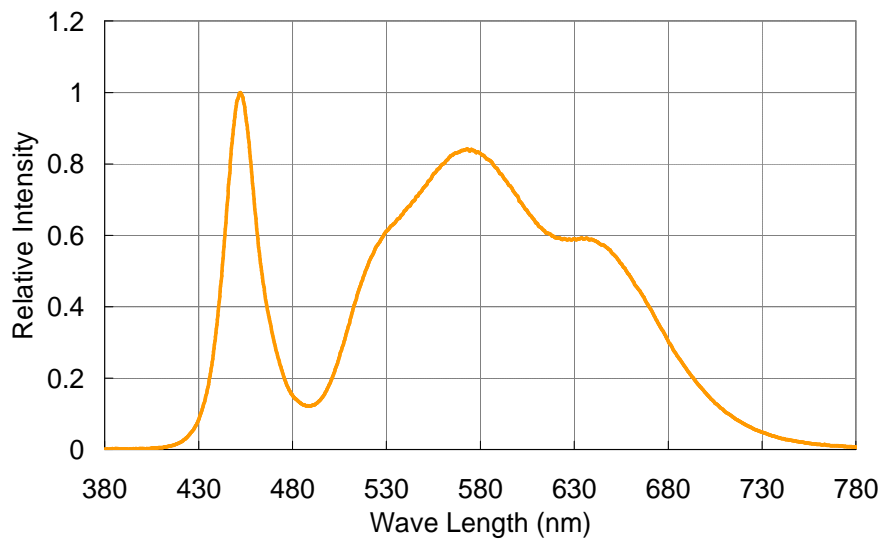

## LUSTRON X5

---

---

**LUSTROUS**<sup>®</sup>  
*GREEN TECHNOLOGY OF LIGHTING*

Cool White (5000K)

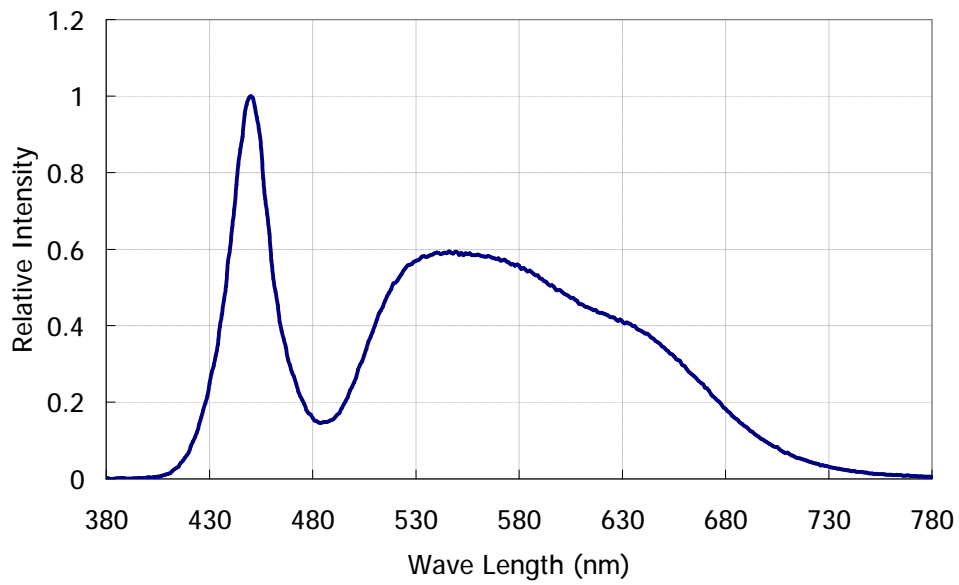

---

**LUSTRON X5**

---

**LUSTROUS**<sup>®</sup>  
GREEN TECHNOLOGY OF LIGHTING

**Typical Angular Beam Profile, T<sub>j</sub>=25°C \***

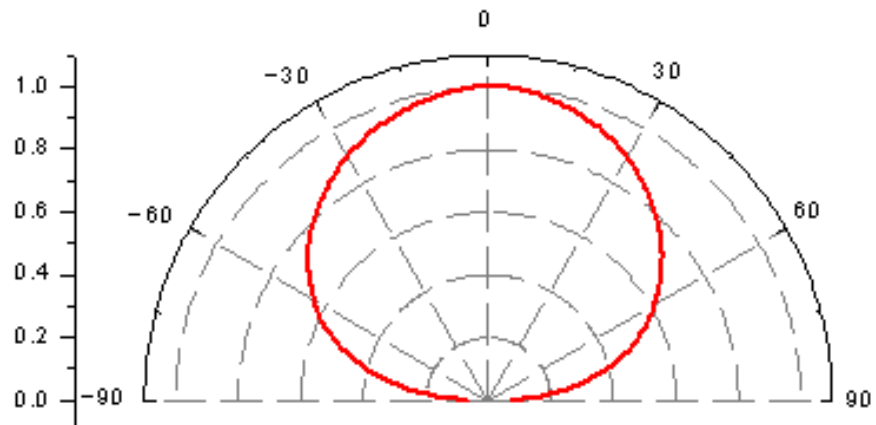

**View Angle: 140 degree**

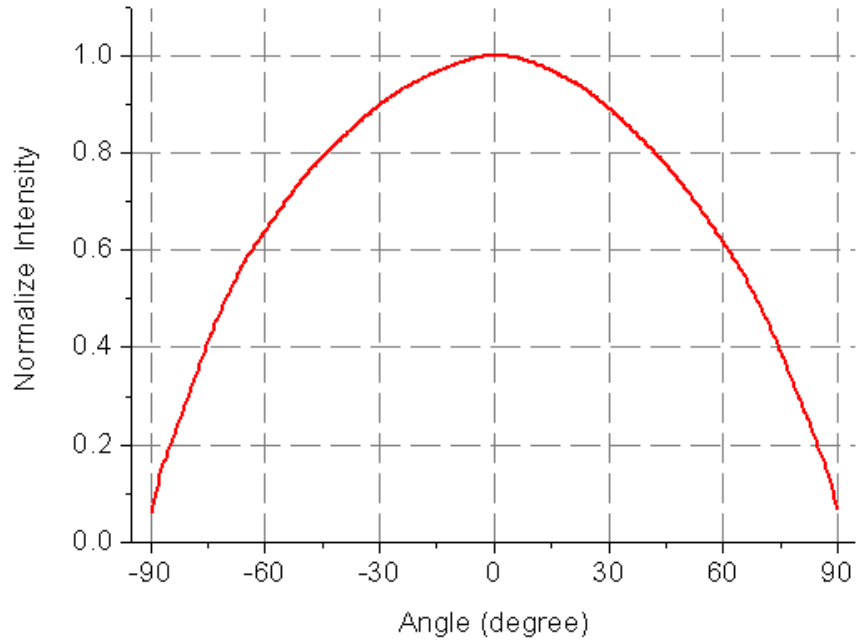

\* Note1 : Photometrics data is ready on request.

**LUSTRON X5**

---

## Product Binning

In the manufacturing process, there is a natural variation of specifications between LEDs. In order to minimize variation in the end product of application, Lustrous Technology uses the current ANSI code binning procedures to measure its products for performance in luminous flux and chromaticity.

The tables below list the standard photometric bins for Lustrous LED products (tested and binned at the indicated test current). **Product availability in a particular bin varies by product and production run. Please contact your Lustrous sales representative for further information regarding product availability.**

## Binning Condition

Table.6

Color	Forward Current (mA)
L510XXCNXX	1050

Color	Forward Current (mA)
L510XXIGXX	350

**LUSTROUS**<sup>®</sup>  
GREEN TECHNOLOGY OF LIGHTING

**Luminous Flux Binning Information \***

Table.7

BIN Code	Lv (lm)	
	min.	max.
A	5	20
B	20	40
C	40	60
D	60	80
E	80	110
F	110	140
G	140	170
H	170	200
I	200	240
J	240	280
K	280	320
L	320	360
M	360	400
N	400	450

BIN Code	Lv (lm)	
	min.	max.
O	450	500
P	500	580
Q	580	660
R	660	740
S	740	860
T	860	980
U	980	1100
V	1100	1300
W	1300	1600
X	1600	2000
Y	2000	2500
Z	2500	3000
A1	3000	3600
A2	3600	4200

\*Note : Luminous flux is measured in total power with tolerance rate of ±10%.

**LUSTRON X5**

**Chromaticity Binning Information \*\***

**Warm White**

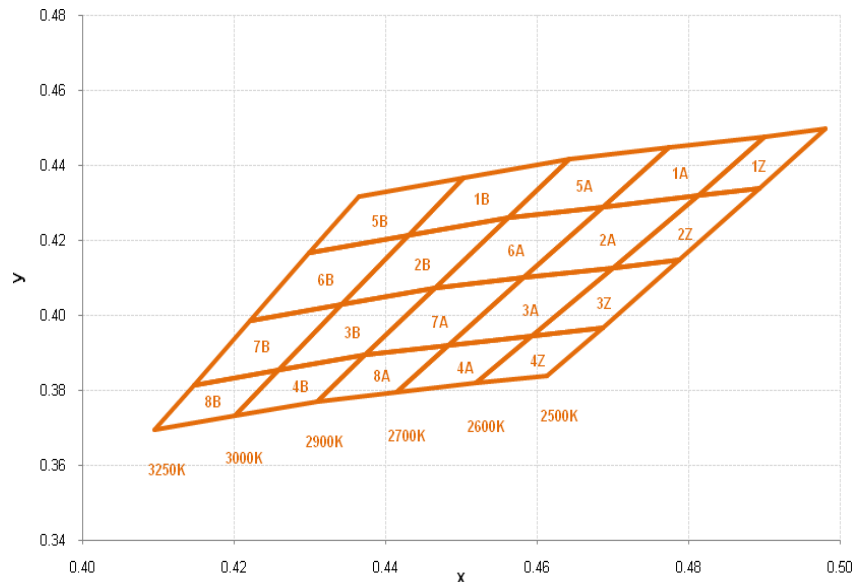

\*\*Note : Chromaticity is measured in Chromaticity Coordinate ( CIE 1931-xy ) with tolerance rate of  $\pm 0.005$ .



<sup>®</sup>  
**LUSTROUS**  
*GREEN TECHNOLOGY OF LIGHTING*

**Table.8**

Warm-White Bin Coordinates												
CCT (K)			BIN CODE	Chromaticity Coordinate (CIE 1931-xy)								
Min	Typ.	Max		x1	y1	x2	y2	x3	y3	x4	y4	
2500	2550	2600	Z	1Z	0.4900	0.4477	0.4980	0.4496	0.4893	0.4338	0.4813	0.4319
				2Z	0.4813	0.4319	0.4893	0.4338	0.4787	0.4146	0.4700	0.4126
				3Z	0.4700	0.4126	0.4787	0.4146	0.4687	0.3965	0.4593	0.3944
				4Z	0.4593	0.3944	0.4687	0.3965	0.4613	0.3839	0.4519	0.3818
2600	2700	2900	A	1A	0.4687	0.4289	0.4774	0.4447	0.4900	0.4477	0.4813	0.4319
				2A	0.4582	0.4099	0.4687	0.4289	0.4813	0.4319	0.4700	0.4126
				3A	0.4483	0.3919	0.4582	0.4099	0.4700	0.4126	0.4593	0.3944
				4A	0.4414	0.3794	0.4483	0.3919	0.4593	0.3944	0.4519	0.3818
				5A	0.4562	0.4260	0.4642	0.4416	0.4774	0.4447	0.4687	0.4289
				6A	0.4465	0.4071	0.4562	0.4260	0.4687	0.4289	0.4582	0.4099
				7A	0.4373	0.3893	0.4465	0.4071	0.4582	0.4099	0.4483	0.3919
				8A	0.4309	0.3769	0.4373	0.3893	0.4483	0.3919	0.4414	0.3794
2900	2950	3000	B	1B	0.4430	0.4212	0.4503	0.4366	0.4642	0.4416	0.4562	0.4260
				2B	0.4342	0.4028	0.4430	0.4212	0.4562	0.4260	0.4465	0.4071
				3B	0.4259	0.3853	0.4342	0.4028	0.4465	0.4071	0.4373	0.3893
				4B	0.4201	0.3731	0.4259	0.3853	0.4373	0.3893	0.4309	0.3769
				5B	0.4299	0.4165	0.4364	0.4316	0.4503	0.4366	0.4430	0.4212
				6B	0.4221	0.3984	0.4299	0.4165	0.4430	0.4212	0.4342	0.4028
				7B	0.4147	0.3814	0.4221	0.3984	0.4342	0.4028	0.4259	0.3853
				8B	0.4095	0.3694	0.4147	0.3814	0.4259	0.3853	0.4201	0.3731

**LUSTRON X5**

**LUSTROUS**<sup>®</sup>  
GREEN TECHNOLOGY OF LIGHTING

**Neutral White**

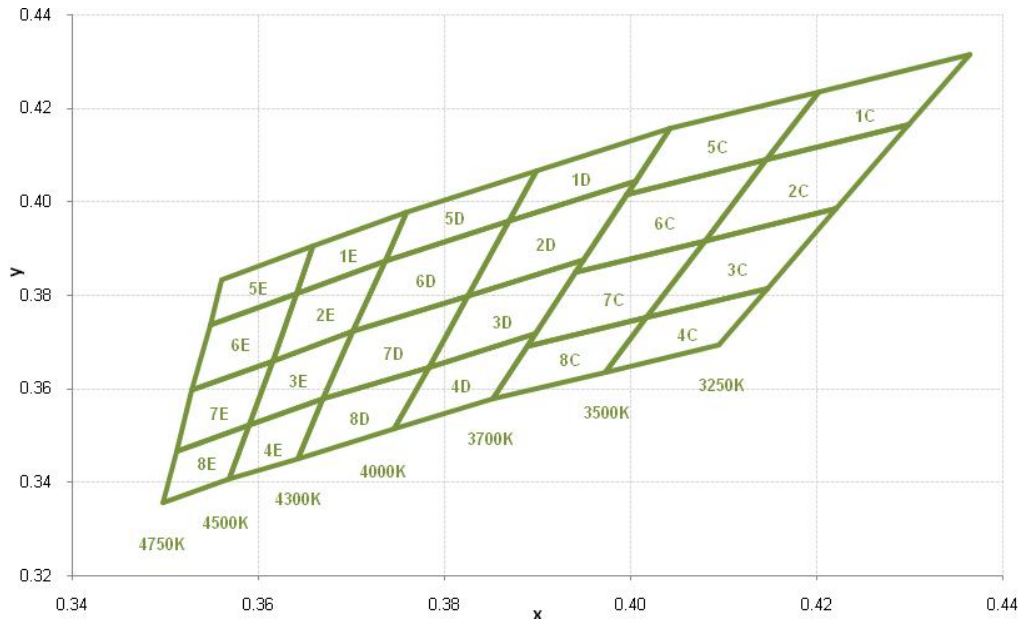

**Table.9**

Natural White Bin Table												
CCT (K)			BIN CODE	Chromaticity Coordinate (CIE 1931-xy)								
Min	Typ.	Max		x1	y1	x2	y2	x3	y3	x4	y4	
3250	3500	3700	C	1C	0.4146	0.4089	0.4202	0.4235	0.4364	0.4316	0.4299	0.4165
				2C	0.4080	0.3916	0.4146	0.4089	0.4299	0.4165	0.4221	0.3984
				3C	0.4017	0.3751	0.4080	0.3916	0.4221	0.3984	0.4147	0.3814
				4C	0.3973	0.3635	0.4017	0.3751	0.4147	0.3814	0.4095	0.3694
				5C	0.3996	0.4015	0.4043	0.4157	0.4202	0.4235	0.4146	0.4089
				6C	0.3941	0.3848	0.3996	0.4015	0.4146	0.4089	0.4080	0.3916

**LUSTRON X5**

# LUSTROUS<sup>®</sup>

## GREEN TECHNOLOGY OF LIGHTING

				7C	0.3889	0.3690	0.3941	0.3848	0.4080	0.3916	0.4017	0.3751
				8C	0.3852	0.3578	0.3889	0.3690	0.4017	0.3751	0.3973	0.3635
3700	4000	4300	D	1D	0.3869	0.3958	0.3899	0.4066	0.4043	0.4157	0.4006	0.4044
				2D	0.3825	0.3798	0.3869	0.3958	0.4006	0.4044	0.3950	0.3875
				3D	0.3783	0.3646	0.3825	0.3798	0.3950	0.3875	0.3898	0.3716
				4D	0.3746	0.3513	0.3783	0.3646	0.3898	0.3716	0.3852	0.3578
				5D	0.3736	0.3874	0.3759	0.3978	0.3899	0.4066	0.3869	0.3958
				6D	0.3702	0.3722	0.3736	0.3874	0.3869	0.3958	0.3825	0.3798
				7D	0.3670	0.3578	0.3702	0.3722	0.3825	0.3798	0.3783	0.3646
				8D	0.3642	0.3450	0.3670	0.3578	0.3783	0.3646	0.3746	0.3513
4300	4500	4750	E	1E	0.3641	0.3804	0.3659	0.3904	0.3759	0.3978	0.3736	0.3874
				2E	0.3615	0.3659	0.3641	0.3804	0.3736	0.3874	0.3702	0.3722
				3E	0.3590	0.3521	0.3615	0.3659	0.3702	0.3722	0.3670	0.3578
				4E	0.3569	0.3407	0.3590	0.3521	0.3670	0.3578	0.3642	0.3450
				5E	0.3548	0.3736	0.3560	0.3832	0.3659	0.3904	0.3641	0.3804
				6E	0.3529	0.3597	0.3548	0.3736	0.3641	0.3804	0.3615	0.3659
				7E	0.3512	0.3465	0.3529	0.3597	0.3615	0.3659	0.3590	0.3521
				8E	0.3498	0.3355	0.3512	0.3465	0.3590	0.3521	0.3569	0.3407

## LUSTRON X5

---

**LUSTROUS**<sup>®</sup>  
*GREEN TECHNOLOGY OF LIGHTING*

**Cool White**

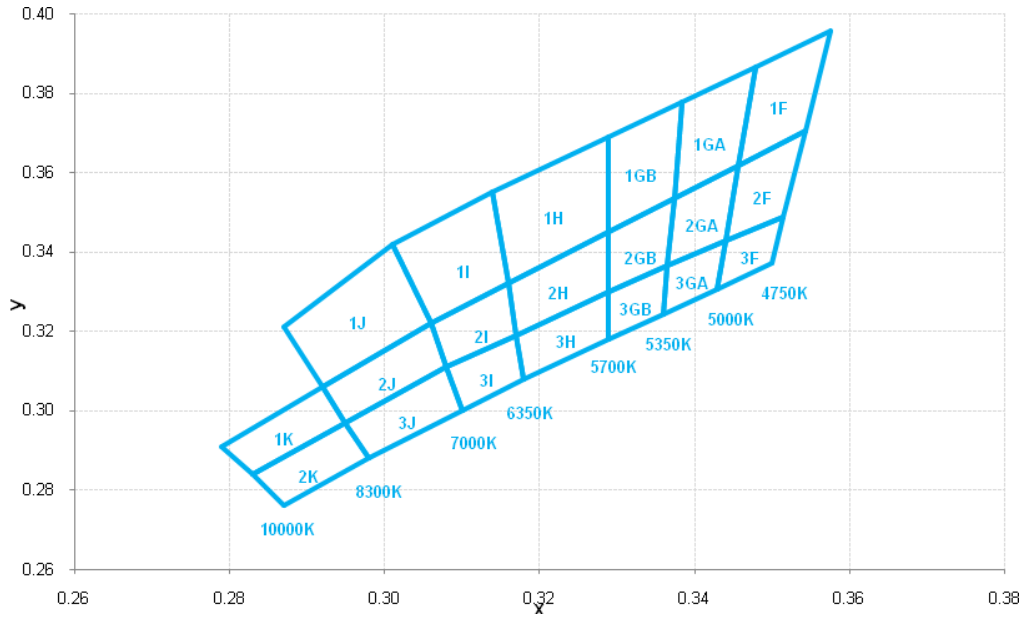

---

**LUSTRON X5**

<sup>®</sup>  
**LUSTROUS**  
*GREEN TECHNOLOGY OF LIGHTING*

**Table.10**

Cool White Bin Table												
CCT (K)			BIN CODE	Chromaticity Coordinate (CIE 1931-xy)								
Min	Typ.	Max		x1	y1	x2	y2	x3	y3	x4	y4	
4750	4850	5000	F	1F	0.3479	0.3867	0.3457	0.3617	0.3544	0.3704	0.3576	0.3957
				2F	0.3457	0.3617	0.3440	0.3429	0.3515	0.3487	0.3544	0.3704
				3F	0.3440	0.3429	0.3429	0.3307	0.3500	0.3371	0.3515	0.3487
5000	5175	5350	G	1GA	0.3385	0.3779	0.3374	0.3534	0.3457	0.3617	0.3479	0.3867
				2GA	0.3374	0.3534	0.3365	0.3365	0.3440	0.3429	0.3457	0.3617
				3GA	0.3365	0.3365	0.3360	0.3244	0.3429	0.3307	0.3440	0.3429
5350	5525	5700	G	1GB	0.3290	0.3690	0.3290	0.3450	0.3374	0.3534	0.3385	0.3779
				2GB	0.3290	0.3450	0.3290	0.3300	0.3365	0.3365	0.3374	0.3534
				3GB	0.3290	0.3300	0.3290	0.3180	0.3360	0.3244	0.3365	0.3365
5700	6000	6350	H	1H	0.3290	0.3690	0.3290	0.3450	0.3160	0.3320	0.3140	0.3550
				2H	0.3290	0.3450	0.3290	0.3300	0.3170	0.3190	0.3160	0.3320
				3H	0.3170	0.3190	0.3290	0.3300	0.3290	0.3180	0.3180	0.3080
6350	6500	7000	I	1I	0.3140	0.3550	0.3160	0.3320	0.3060	0.3220	0.3010	0.3420
				2I	0.3160	0.3320	0.3170	0.3190	0.3080	0.3110	0.3060	0.3220
				3I	0.3080	0.3110	0.3170	0.3190	0.3180	0.3080	0.3100	0.3000
7000	7650	8300	J	1J	0.3010	0.3420	0.3060	0.3220	0.2920	0.3060	0.2870	0.3210
				2J	0.3060	0.3220	0.3080	0.3110	0.2950	0.2970	0.2920	0.3060
				3J	0.2950	0.2970	0.3080	0.3110	0.3100	0.3000	0.2980	0.2880
8300	9000	10000	K	1K	0.2920	0.3060	0.2950	0.2970	0.2830	0.2840	0.2790	0.2910
				2K	0.2830	0.2840	0.2950	0.2970	0.2980	0.2880	0.2870	0.2760

**LUSTRON X5**

# LUSTROUS<sup>®</sup>

GREEN TECHNOLOGY OF LIGHTING

## Print Code Guideline

L5 10 NW C N D A  
 1 2 3 4 5 6 7

XXXXXXXXXXXXXXXXXX

8

V0 -V -2GA XX XX XX  
 9 10 11 12 13 14

Table.11

1 Type	2 Power	3 Color	4 Vf	5 Current	6 CRI
<b>L5</b>	<b>10</b> : 10W	<b>NW</b> : Cool White <b>MW</b> : Neutral White <b>CL</b> : Warm White	<b>C</b> : 10.5 V <b>I</b> : 31.5 V	<b>N</b> : 1050 mA <b>G</b> : 350 mA	<b>B</b> : 80~90 <b>D</b> : 60~70

7 Customer Code	8 Internal Code	9 Bin Vf	10 Luminous Flux	11 Chromaticity
		<b>V0</b> : Without Binned	See Bin Code Definition	See Bin Code Definition

12 Year	13 Month	14 Week
<b>12</b> : 2012	<b>01</b> : January	<b>01</b> : 01 <sup>st</sup> Week
<b>13</b> : 2013	<b>05</b> : May	<b>20</b> : 20 <sup>th</sup> Week
<b>14</b> : 2014	<b>10</b> : October	<b>45</b> : 45 <sup>th</sup> Week

## LUSTRON X5

**LUSTROUS**<sup>®</sup>  
GREEN TECHNOLOGY OF LIGHTING

**Standard Packaging**

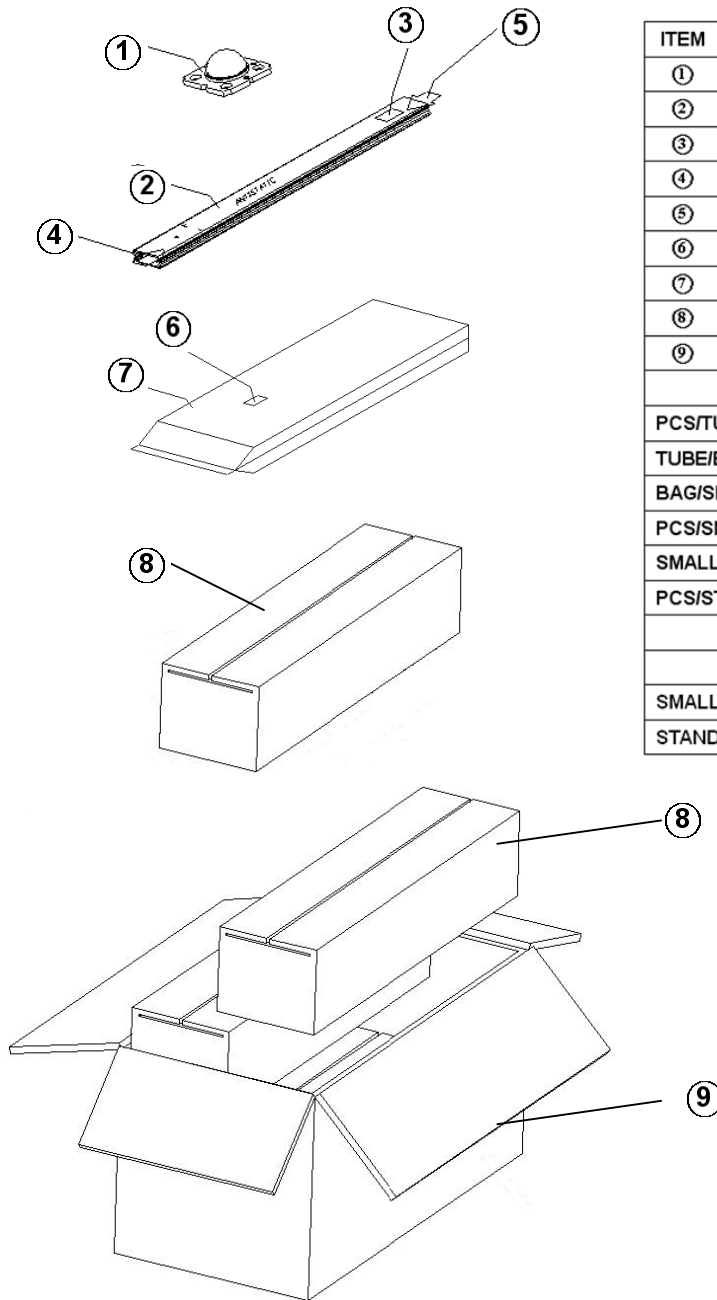

ITEM	DESCRIPTION	
①	LED	
②	PLASTIC TUBE	
③	ADHESIVE MAIN LABEL	
④	END-PLUG WHITE	
⑤	END-PLUG BLACK	
⑥	ADHESIVE MAIN LABEL	
⑦	MOISTURE BARRIER BAG	
⑧	SMALL BOX	
⑨	STANDARD BOX	
STACKING METHOD		
PCS/TUBE		10
TUBE/BAG		10
BAG/SMALL BOX		2
PCS/SMALL BOX		200
SMALL BOX/STANDARD BOX		4
PCS/STANDARD BOX		800
SIZE AND WEIGHT		
	SIZE(mm <sup>3</sup> )	WEIGHT(kg)
SMALL BOX	560x130x130	3.7±0.5
STANDARD BOX	580x280x280	15.5±0.5

**LUSTRON X5**

## Precaution for Use

### Installation

1. Do not touch the lighting surface area during installation.
2. If the product might to be used under the following conditions, the customer must evaluate its appropriateness them. This product is not designed for use under the following conditions.

In places where the product might:

- I get wet due to rain.
- I suffer from damage caused by salt.
- I be exposed to corrosive gas such as Cl, S, H<sub>2</sub>S, NH<sub>3</sub>, SO<sub>2</sub>, NO<sub>x</sub> and so on.
- I be exposed to dust, fluid or oil.

### Over-current Proof

1. Do not reverse current the LEDs we suggest current limit resistors for extra protection.
2. The maximum overshoot current should be limited to 130% of normal drive current.
3. The ripple of driving current should not exceed +/-10% of normal driving current.
4. The typical driving current for L510XXCNXX / L510XXIGXX series is 1050mA / 350mA.
5. When driving L510XXCNXX / L510XXIGXX series, the clamp voltage must be set at 12V / 36V.

### Storage

1. Do not open the Moisture Barrier Bag (MBB) before you are ready to install the LEDs.
2. Storage Condition ( before opening the MBB ) :
  - I Storage Temperature:-20~50°C.
  - I Relative Humidity: <60% RH.
  - I Please re-seal the MBB when storing longer than 3 weeks.
  - I The products should be used within half a year.
3. Storage Condition ( after opening the MBB ) :
  - I Storage Temperature:-20~50°C.
  - I Relative Humidity: <60% RH.



---

# LUSTROUS<sup>®</sup>

*GREEN TECHNOLOGY OF LIGHTING*

- I The products should used or installed as soon as possible after opening the MBB. Otherwise, the LED product must be baked at 80+/-5°C, 24 hours before installation.

**LUSTRON X5**

---

---

**LUSTROUS**<sup>®</sup>  
GREEN TECHNOLOGY OF LIGHTING

## Company Information

---

Lustrous Technology, founded in 2004, endeavors to bring a new era of solid-state lighting. Our R&D development center and production facilities are based in Taiwan, a famous island for IT technology in the world. Our products are well designed in both performance and reliability. Lustrous is one of the leading high-power LED manufacturer and solution provider in the world.

\*\*Lustrous Technology may make process and material changes affecting performance and characteristics of our products without further notice. These products supplied after changes will continue to meet published specifications, but may not be identical to products supplied as samples or under prior orders.

**LUSTROUS**<sup>®</sup>  
*Green Technology of Lightings*

Website : [www.lustrous.com.tw](http://www.lustrous.com.tw)

Email : [sales@lustrous.com.tw](mailto:sales@lustrous.com.tw)

Tel : +886-2-8647-2862

Fax : +886-2-8647-2863

*All rights reserved. Product specifications are subject to change without further notice.*

**LUSTRON X5**

---