

Model	Size	Angle
SB-LENS-38P	Φ19.80×H11.20	38

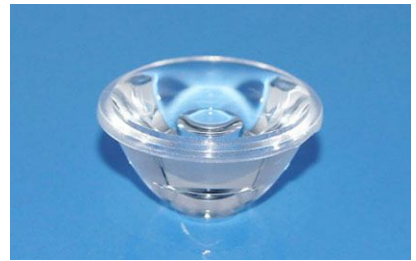

Materials: PMMA
 Temperature Resistance: 90°C

Lens:

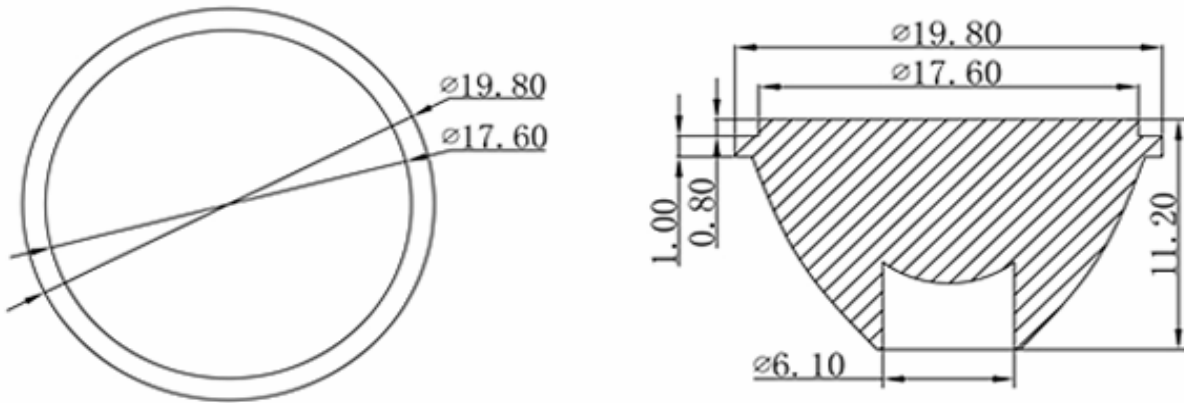

Holder:

