

Model	Size	Angle
SB-LENS-30P	Φ19.80×H11.20	30

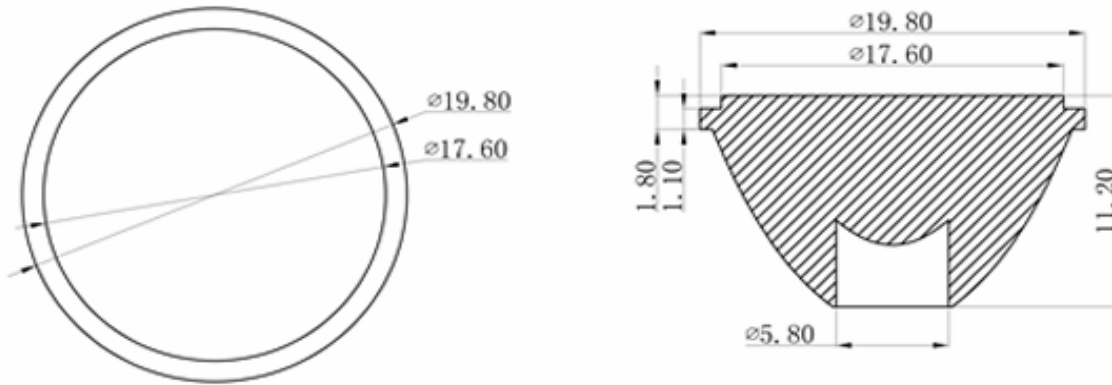

Materials: PMMA  
 Temperature Resistance: 90°C

Lens:



Holder:

